



5 IN 1 CRIB

Read all instructions before assembly and use.
KEEP INSTRUCTIONS FOR FUTURE USE.

▲ ADULT ASSEMBLY REQUIRED

Due to the presence of small parts during assembly, keep out of reach of children until assembly is complete.



THIS PRODUCT IS NOT INTENDED FOR INSTITUTIONAL OR COMMERCIAL USE.

Scan the QR code to register your product
<https://dreamonme.com/customer-care/registration/>



style #: 761

MFG date: Aug 2017

Consumer Care:
www.dreamonme.com
1532 S WASHINGTON AVE
PISCATAWAY TWP NJ 08854
Email: info@dreamonme.com
www.dreamonme.com

When contacting Dream On Me you will need to reference the above numbers. They can also be found on the label on the Crib End bottom rail.

To register your product for important safety alerts and updates to your product please visit www.dreamonme.com and click on Product Registration.

CAUTION:

ANY MATTRESS USED IN THIS CRIB SHALL BE AT LEAST 27 1/4 BY 51 5/8 IN. WITH A THICKNESS NOT EXCEEDING 6 IN.

WARNING:

- Infants can suffocate on soft bedding. Never add a pillow or comforter. Never place additional padding under an infant.
- Failure to follow these warnings and the assembly instructions could result in serious injury or death. DO NOT use this crib if you cannot exactly follow the accompanying instructions.
- To reduce the risk of SIDS, pediatricians recommend healthy infants be placed on their backs to sleep, unless otherwise advised by your physician.
- Strangulation Hazard: STRINGS CAN CAUSE STRANGULATION! Do not place items with a string around a child's neck, such as hood strings or pacifier cords. Do not suspend strings over a crib or attach strings to toys. Strangulation Hazard: To help prevent strangulation tighten all fasteners. A child can trap parts of the body or clothing on loose fasteners.
- Strangulation Hazard: Do not place crib near window or patio door where cords from blinds or drapes may strangle a child.
- Fall Hazard: When child is able to pull to a standing position, set mattress to lowest position and remove bumper pads, large toys and other objects that could serve as steps for climbing out. This crib has an adjustable mattress support. For the convenience of the parent when the baby is very small, the mattress support may be used in the highest position. Important: with the mattress support and mattress in the highest position, be absolutely sure that the top of the front crib side is at least 3 inches higher than the top surface of the mattress. If it is not, lower the mattress support and the mattress to the next highest position.
- Fall Hazard: Stop using crib when child begins to climb out or reaches a height of 35 in (89 cm), whichever occurs first. The child should be placed in a youth or regular bed.
- Check this product for damaged hardware, loose joints, loose bolts or other fasteners, missing parts, or sharp edges before and after assembly and frequently during use. Securely tighten loose bolts and other fasteners. Do not use crib if any parts are missing, damaged or broken. Contact Dream On Me for replacement parts and instructional literature if needed. Do not substitute parts.
- Follow warnings on all products in a crib.
- If refinishing, use a non-toxic finish specified for children's products.
- Never use plastic shipping bags or other plastic film as mattress covers because they can cause suffocation.
- Infants can suffocate in gaps between crib sides and a mattress that is too small.
- Ensure a safe environment for the child by checking regularly, before placing the child in the crib, that every component is properly and securely in place.
- To avoid head injury, do not allow any child to play underneath the crib.
- Never add an accessory such as a bassinet or changing table that extends over the sleeping area.
- In Canada Only-Use a crib mattress that is no thicker than 15 cm and is of such a size that, when it is pushed firmly against any side of the crib, it does not leave a gap of more than 3 cm between the mattress and any part of the sides of the crib. Do not use this crib for a child who can climb out of it or who is taller than 90 cm.

TODDLER BED

WARNING:

INFANTS HAVE DIED IN TODDLER BEDS FROM ENTRAPMENT.

Openings in and between bed parts can entrap head and neck of a small child.

NEVER use bed with children younger than 15 months.

ALWAYS follow assembly instructions.

The maximum user weight is 50lbs(22.7kg)

WARNING

STRANGULATION HAZARD

NEVER place bed near windows where cords from blinds or drapes may strangle a child.

NEVER suspend strings over a bed.

NEVER place items with a string, cord, or ribbon, such as hood strings or pacifier cords, around a child's neck. These items may catch on bed parts.

CAUTION

ENTRAPMENT HAZARD

To avoid dangerous gaps, any mattress used in this bed shall be a full-size crib mattress at least 51 5/8 in (1310mm) in length, 27 1/4 (690mm) in width and 4 in (100mm) in thickness. The mattress thickness must not exceed 6 in(150mm).

NOTES ON ASSEMBLY:

- During the assembly process whenever using screws or bolts, check each by placing the screw/bolt on the diagram of the item which is drawn actual size and design. Be sure to use the proper size and shape specified in the instructions.
- To assemble this unit you may be required to place the unit on it's side and face. It is strongly recommended that assembly is done on a soft, non-abrasive surface to avoid damaging the finish.

NOTES ON USE:

Keep children and others safe by following these simple rules:

- **Do not** allow any child to play on furniture.
- **Do not** allow climbing on any piece of furniture.
- **Do not** allow hanging from any piece of furniture.
- Always monitor your child's activity when in the nursery.

NOTES ON CARE AND MAINTENANCE:

- **Do not** scratch or chip the finish.
- Inspect the product periodically, contact Dream On Me for replacement parts or questions.
- Do not store the product or any parts in extreme temperatures and conditions such as a hot attic or a damp, cold basement. These extremes can cause a loss of structural integrity.
- To preserve the luster of the high quality finish on your product, it is recommended to place a doily or felt pad under any items you place on the finish.
- Clean with a damp cloth, then a dry cloth to preserve the original luster and beauty of this fine finish.
- **Do not** use abrasive chemicals.
- **Do not** spray cleaners directly onto furniture.
- Lift slightly when moving on carpeting to prevent leg breakage.
- Use of a vaporizer near furniture will cause wood to swell and finish to peel.

ATTENTION!

Respecter les avertissements sur tous les produits du berceau.

L'assemblage par un adulte est nécessaire.

Les petites pièces peuvent présenter un danger d'étranglement avant l'assemblage.

Ci-joint s'il vous plaît trouver les instructions simples, étape par étape pour vous aider à assembler rapidement vos produits. Avant de commencer, nous vous recommandons de suivre les étapes ci-dessous:

1. Lire attentivement les instructions, s'il vous plaît.

2. Identifier toutes les pièces et le matériel.

3. Vous aurez besoin des outils suivants:

Tournevis tête phillips

Tournevis à tête plate

Marteau

Ne pas utiliser les perceuses ou pilotes

Pour protéger vos pièces lors de l'assemblage, placez-les sur une surface molle.

Pour nettoyer la surface, utiliser seulement l'eau et un chiffon humide.

Ne pas utiliser des nettoyeurs pour vitres ou des abrasifs de nettoyage car il va rayer la surface et pourrait endommager le revêtement protecteur.

Le non-respect de ces avertissements et instructions peut entraîner des blessures graves ou la mort.

Lisez toutes les instructions avant l'assembler du crèche, garder les instructions pour une utilisation future.

À l'issue de l'assemblée, assurez-vous que toutes les vis, les boulons et les dispositifs de fixation ont été bien serrés. Un contrôle fréquent doit être fait.

Ne jamais utiliser ce produit s'il y a des pièces desserrées ou manquantes, des joints lâches, des pièces cassées ou maille/tissu déchiré. Vérifiez avant le montage et périodiquement pendant l'utilisation. Contactez DREAM ON ME pour les pièces de rechange et des instructions, si nécessaire. Ne jamais substituer les parties, y compris le produit des rails latéraux, doivent être complètement érigé avant utilisation. Cesser d'utiliser le produit lorsque l'enfant est capable de sortir ou atteint la hauteur de 35 pouces (890mm).

Ne placez jamais ce produit près de la fenêtre où les cordons de stores ou rideaux peuvent étrangler un enfant.

Lorsque l'enfant est capable de tirer à la position debout, placez le matelas/base à la plus basse position de réglage et enlever les bordures de protection, les gros jouets et d'autres objets qui pourraient servir de marches pour grimper. Un enfant peut piéger les parties du corps ou les vêtements sur des fixations desserrées. Ne jamais utiliser de sac en plastique

de transport ou tout autre film plastique pour recouvrir le matelas non vendu et conçus à cette fin, ils peuvent provoquer la suffocation.

ATTENTION: Tout matelas utilisé dans ce lit doit être au moins 27-1/4 pouces (690mm) par 51-5/8 pouces (1310mm), avec une épaisseur n'excédant pas 6 pouces (150 mm), les dimensions du matelas doivent être prises de la couture à la couture ou bord à bord dans le cas échéant.

Ne jamais utiliser un matelas à eau avec ce produit.

Les cordes peuvent étrangler! Ne jamais placer des objets avec une chaîne autour du cou de l'enfant, tels que les chaînes de capot ou de cordons de sucette. Ne jamais suspendre de ficelles sur le produit ou attacher des ficelles aux jouets.

Les bébés peuvent être suffoqués dans les espaces entre un matelas trop petit ou trop épais au côtés et des produits, ne jamais ajouter un matelas, un oreiller, une couette ou un rembourrage sur un matelas mou.

Pour réduire le risque de SMSN, les pédiatres recommandent que les enfants en bonne santé doivent être placés sur le dos pour dormir, sauf avis contraire de votre médecin.

Si la finition, utilisez un fini non toxique indiqué pour les produits pour enfants.

Les bébés peuvent suffoquer sur un matelas mou.

Ne jamais ajouter un coussin ou une couverture.

Ne placez jamais un rembourrage supplémentaire en vertu d'un nourrisson.

Pour aider à prévenir l'étranglement, serrer toutes les fixations. .

Un enfant peut piéger les parties du corps ou les vêtements sur des fixations desserrées.

Respecter les avertissements sur tous les produits du berceau.

Voir panneau tête et support du matelas du produit pour les avertissements.

Remplacer dentition ferroviaire si endommagé, fissuré ou lâche.

FABRIQUÉ EN CHINE

PARTS: MAKE SURE THAT ALL PRE-ASSEMBLED PARTS ARE TIGHT.

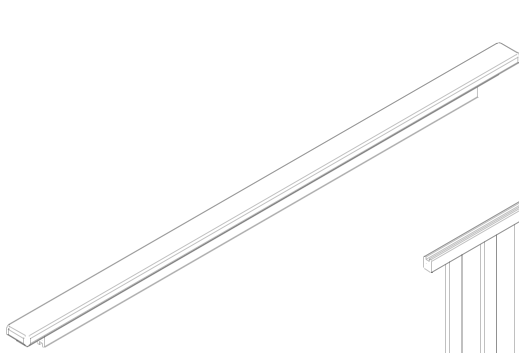

A. Back Rail Top

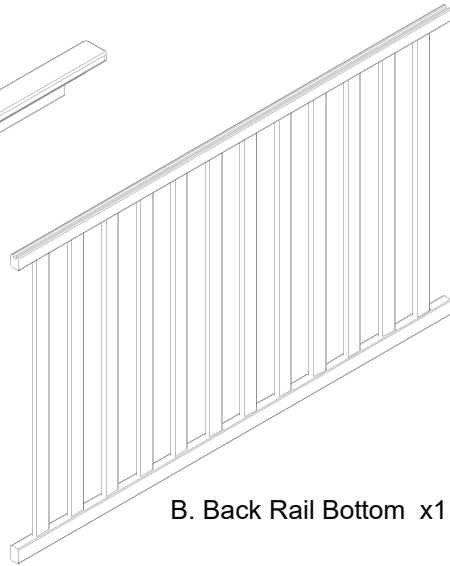

B. Back Rail Bottom x1

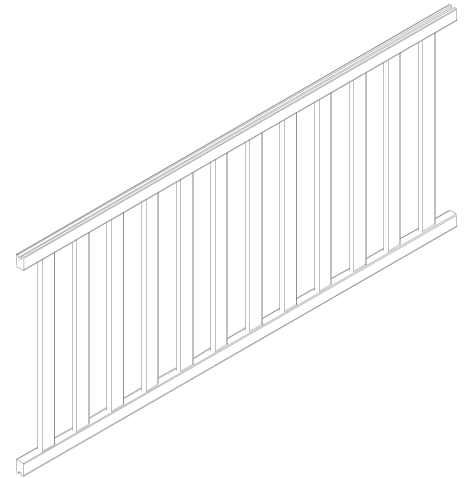

C. Front Rail x1

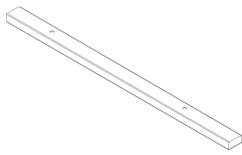

D. Left Crib End Top x1

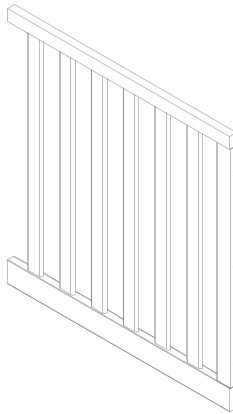

F. Crib End x2

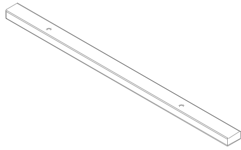

E. Right Crib End Top x1



G. Left Rear Leg x1



H. Right Rear Leg x1

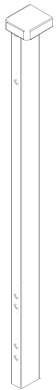

J. Left Front Leg x1



K. Right Front Leg x1

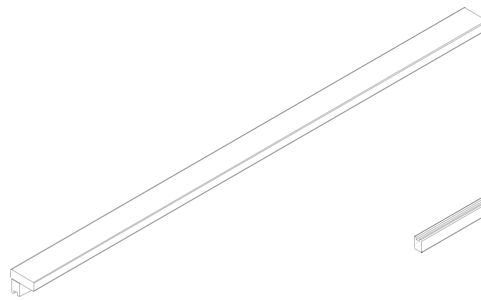

L. Front Rail Top



M. Stabilizer Bar 1 x1

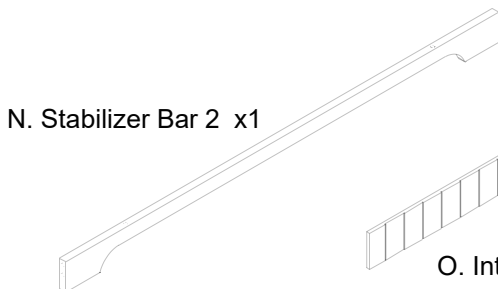

N. Stabilizer Bar 2 x1

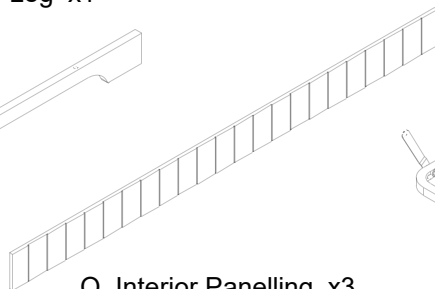

O. Interior Panelling x3

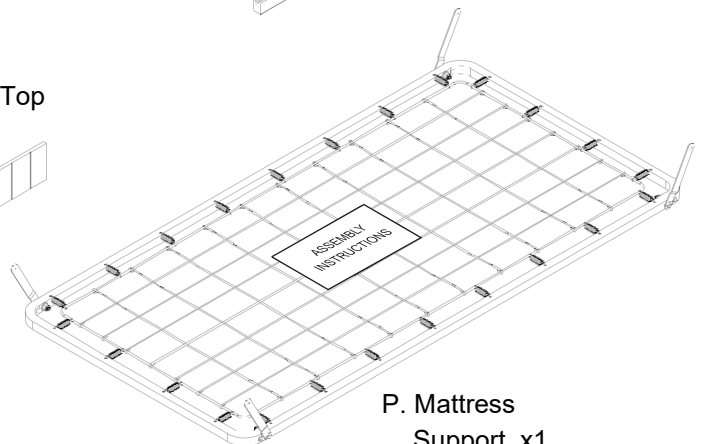

P. Mattress Support x1

PARTS: HARDWARE AND TOOLS



a. 3-2/5" Bolt x16

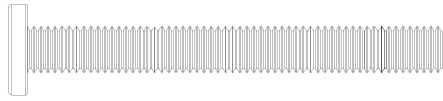

b. 2-1/5" Bolt x12

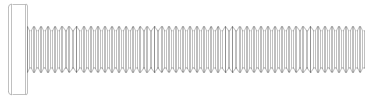

c. 1-3/4" Bolt x4

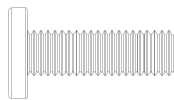

d. 3/4" Bolt x4
(Painted blue)



M4 ALLEN
WRENCH SUPPLIED



g. Barrel nuts x20

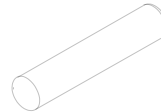

h. Dowel x2



No drills necessary.
Do not use power
screwdriver

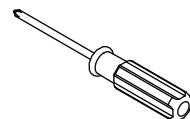

Phillips Screwdriver
(not supplied)

SECTION 1: CRIB ASSEMBLY

Parts and tools required to complete step.

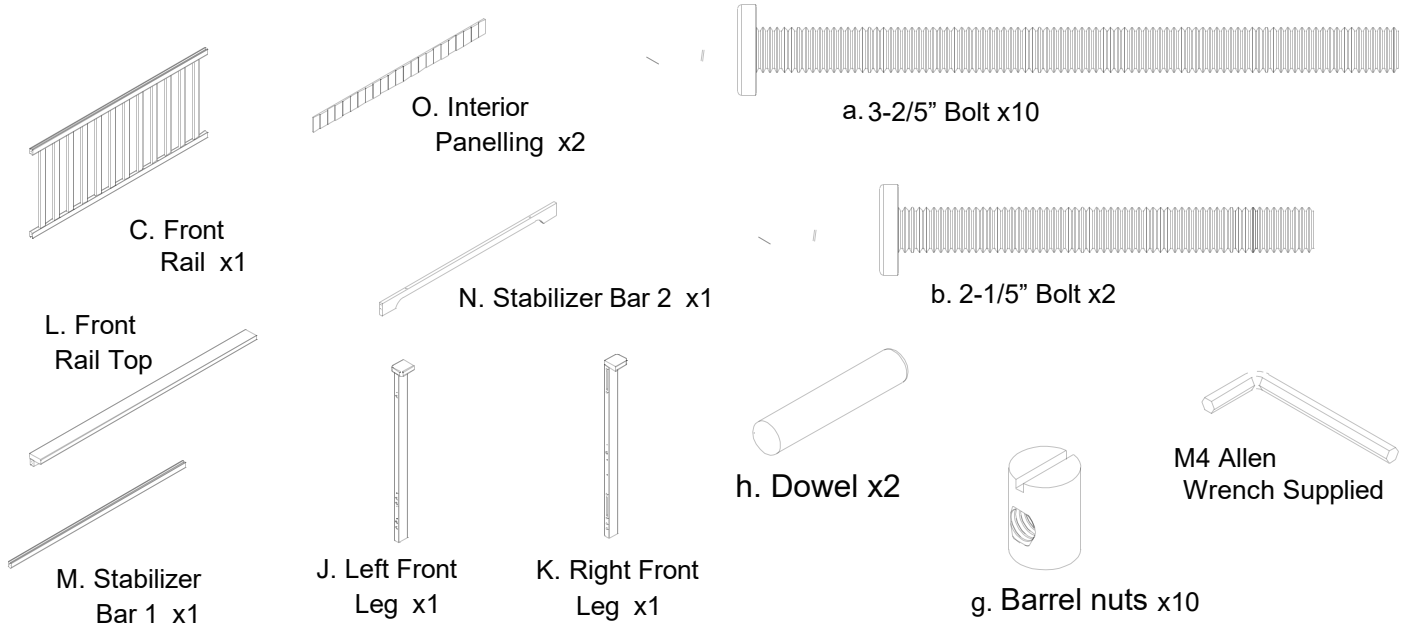

Attach (1) Front Rail Top (Part L), (2) Interior Panelling (Part O), (1) Front Rail Bottom (Part C), (1) Stabilizer Bar 1 (Part M), (1) Stabilizer Bar 2 (Part N) to (1) Left Rear Leg (Part G) and (1) Left Front Leg (Part J), using (2) 2-1/5" Bolts (Part b), (10) 3-2/5" Bolts (Part a), (10) Barrel nuts (Part g) and (2) Dowel (Part h). Tighten with the M4 Allen Wrench.

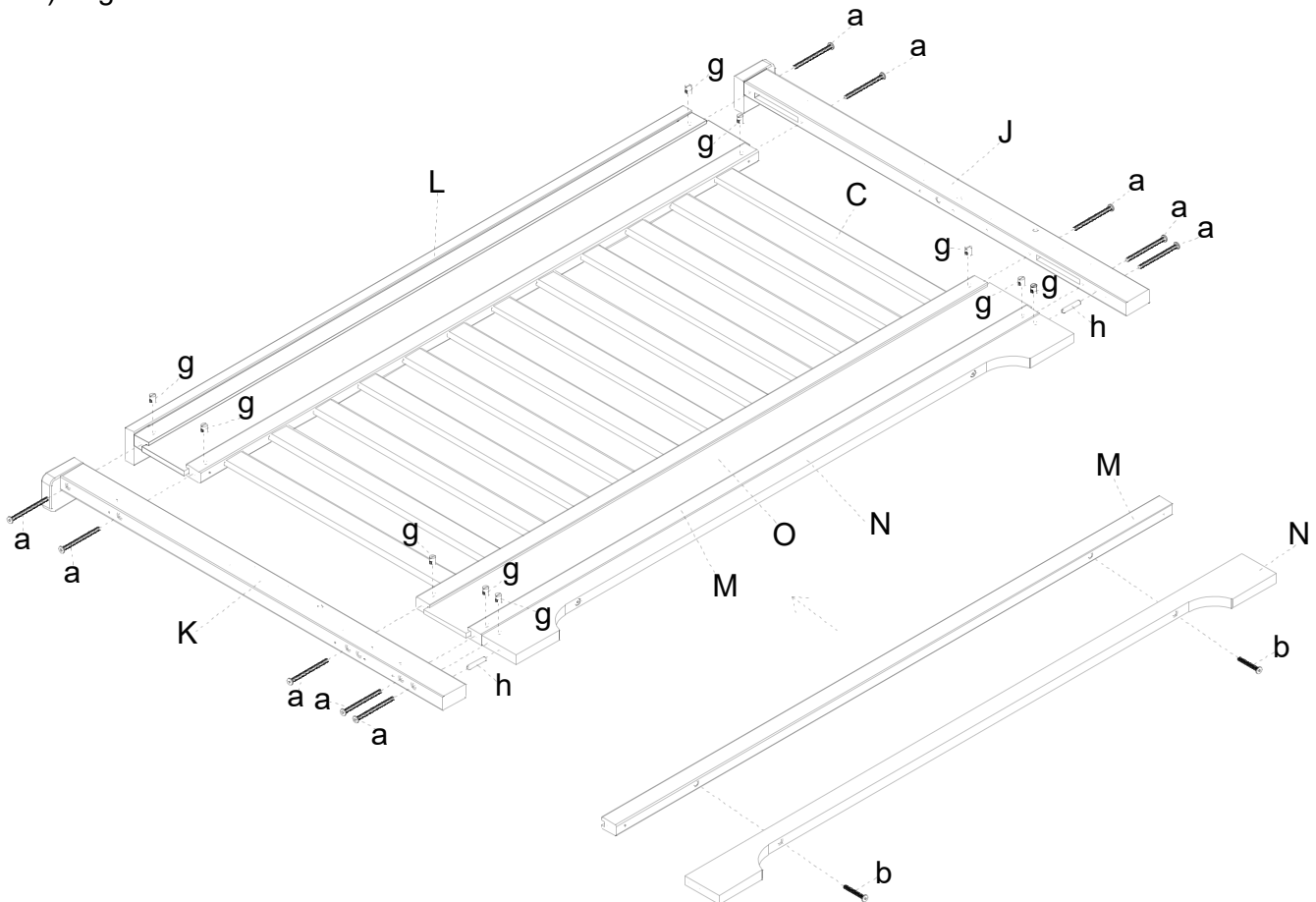

SECTION 1: CRIB ASSEMBLY

STEP 2

Parts and tools required to complete step.

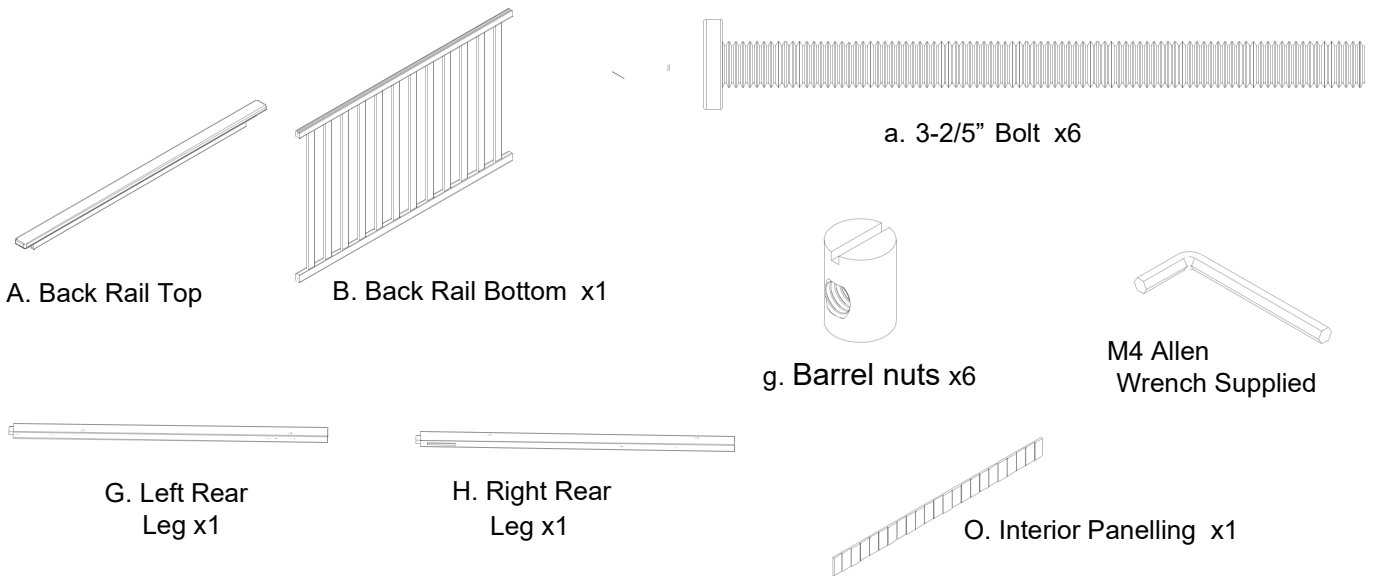

Attach (1) Back Rail Top (Part A), (1) Interior Panelling (Part O), (1) Back Rail Bottom (Part B) to (1) Left Rear Leg (Part G) and (1) Right Rear Leg (Part H) using (6) 3-2/5" Bolts (Part a) and (6) Barrel nuts (Part g). Tighten with the M4 Allen Wrench.

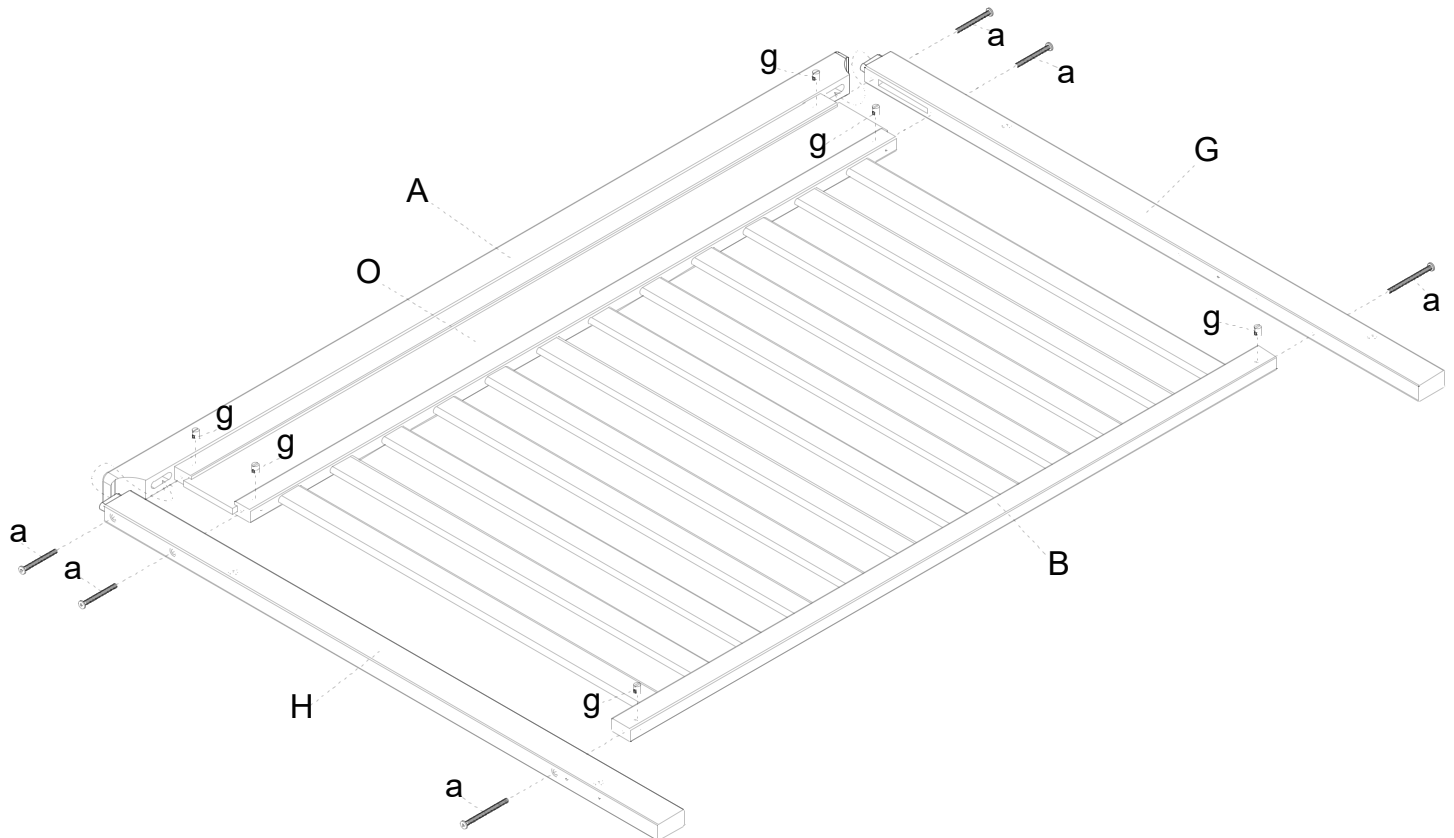

SECTION 1: CRIB ASSEMBLY

STEP 3

Parts and tools required to complete step.

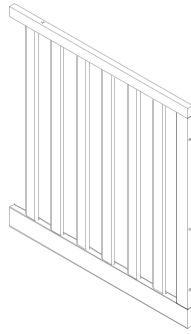

Attach (1) Left Crib End Top (Part D) to (1) Crib End (Part F) using (2) 1-3/4" Bolts (Part c). Tighten with the M4 Allen Wrench.

Attach (1) Right Crib End Top (Part E) to (1) Crib End (Part F) using (2) 1-3/4" Bolts (Part c). Tighten with the M4 Allen Wrench.

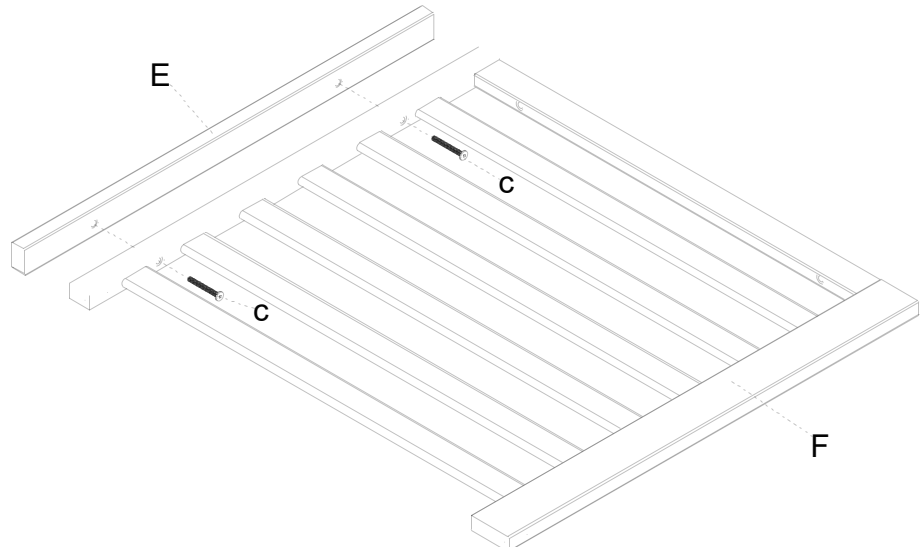
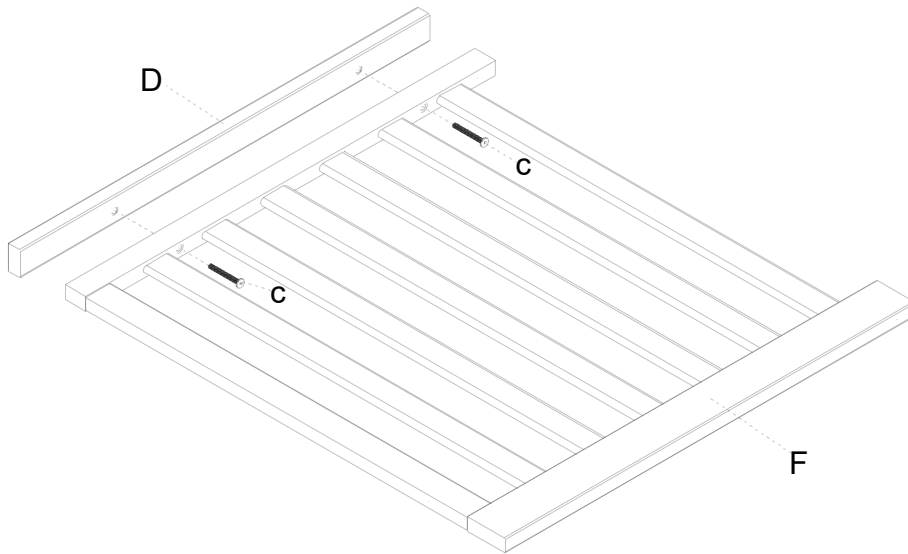

SECTION 1: CRIB ASSEMBLY

STEP 4

Parts and tools required to complete step.

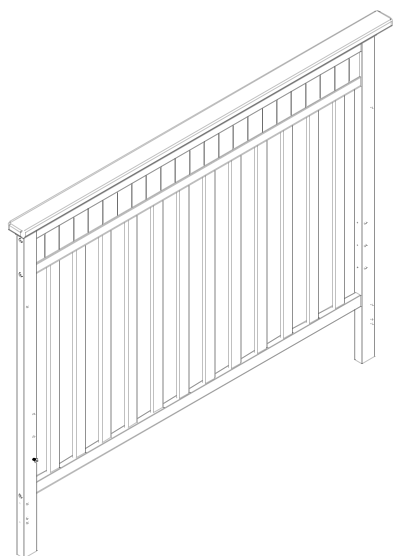

From Step 2

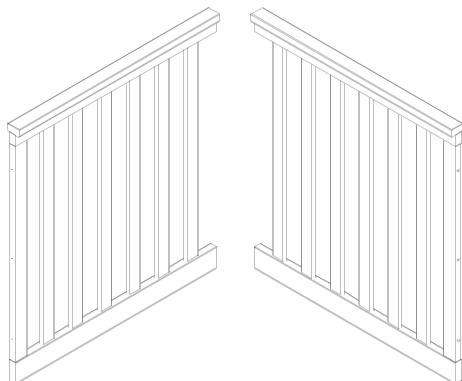

From Step 3



b. 2-1/5" Bolt x4

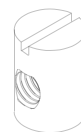

g. Barrel nuts x4

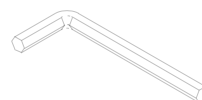

M4 Allen
Wrench Supplied

Install The Assembly From 3 To The Assembly From 2 using (4) 2-1/5" Bolts (Part b) and (4) Barrel nuts (Part g). Tighten with the M4 Allen Wrench.

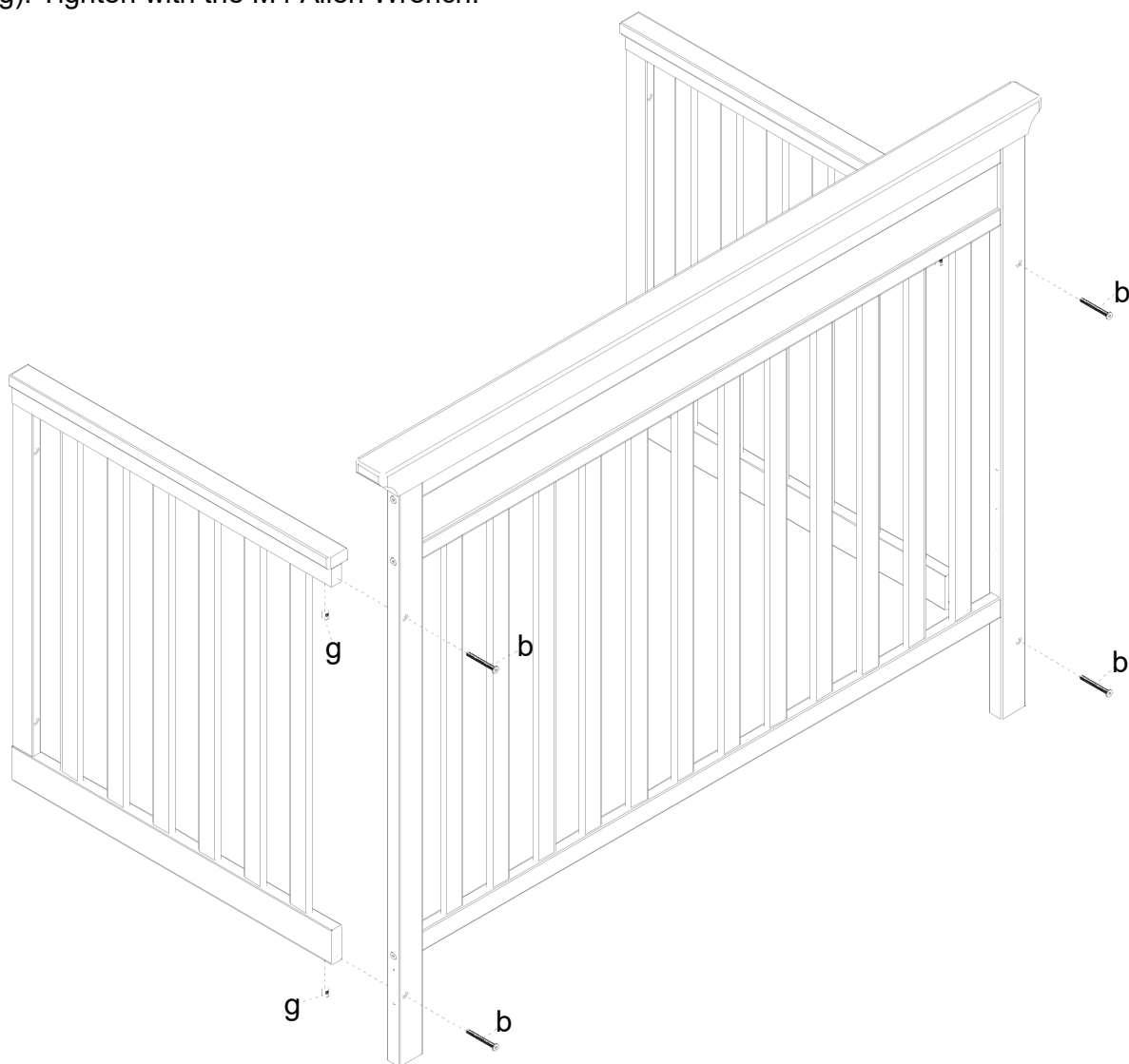

SECTION 1: CRIB ASSEMBLY

STEP 5

Parts and tools required to complete step.

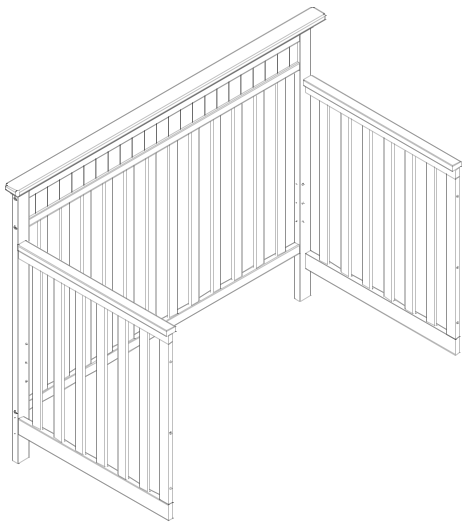

From Step 4

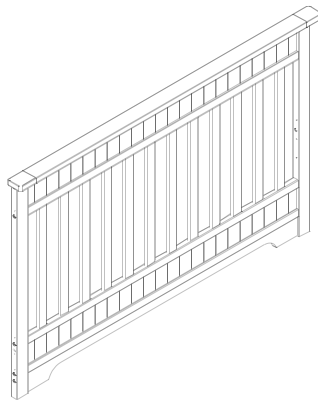

From Step 1

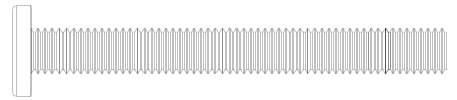

b. 2-1/5" Bolt x6

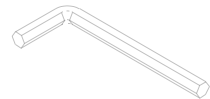

M4 Allen
Wrench Supplied

Install The Assembly From 4 To The Assembly From 1 using (6) 2-1/5" Bolts (Part b) .
Tighten with the M4 Allen Wrench.

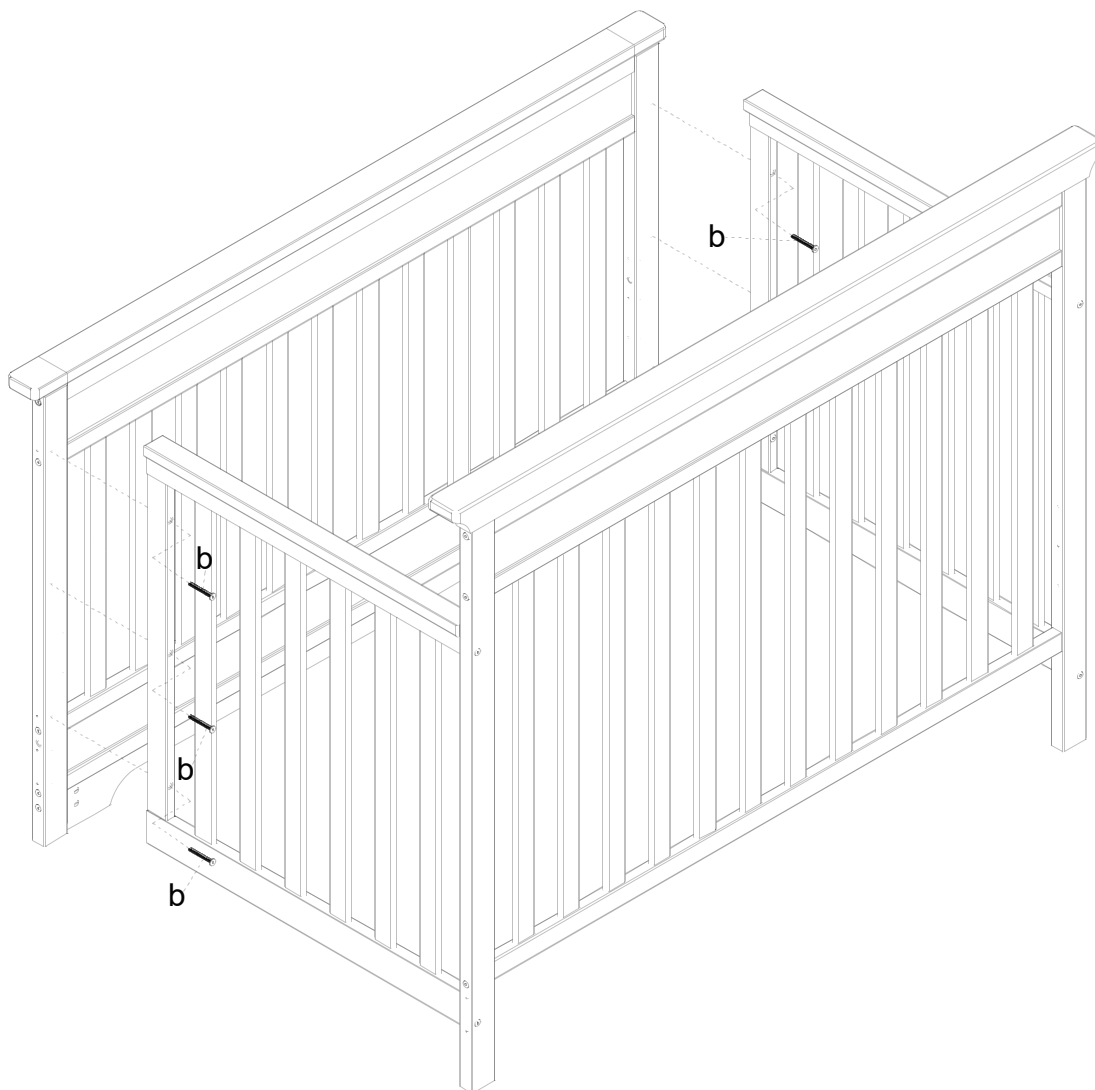

SECTION 1: CRIB ASSEMBLY

STEP 6

Parts and tools required to complete step.

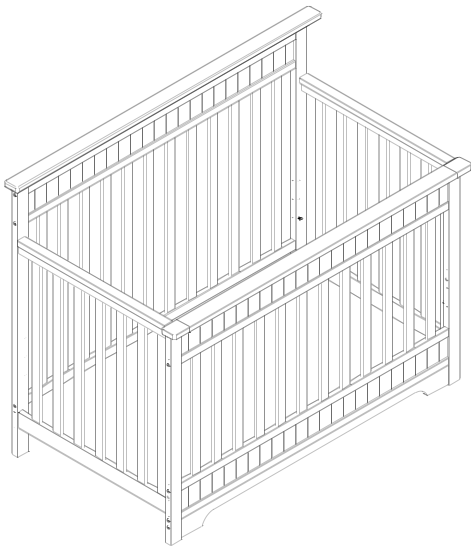

From Step 5

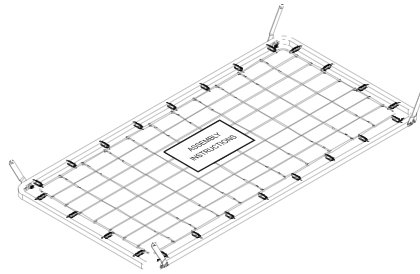

P. Mattress Support x1

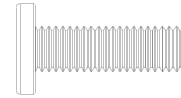

d. 3/4" Bolt x4
(Painted blue)



M4 Allen Wrench Supplied

Attach (1) Mattress Support (Part P) To The Assembly From 5 Using (4) 3/4" Bolts (Part D) . Tighten With The M4 Allen Wrench.

ALL CORNERS

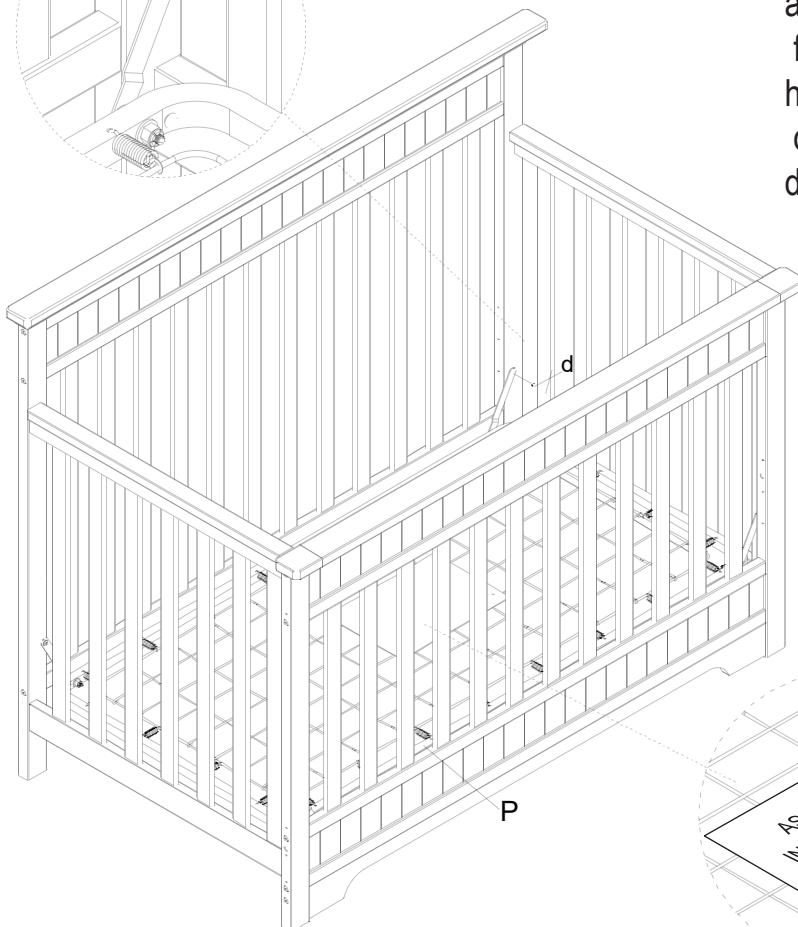
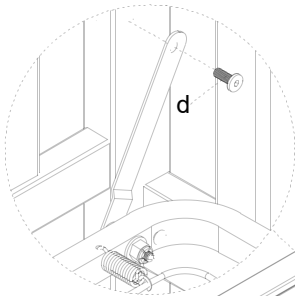

The  Warnings printed on the pouch attached to the mattress support must face up, the springs must face up. This crib has adjustment positions, use the highest only for new borns, move the mattress down as the child grows.

WARNING:

Fall Hazard: When child is able to pull to a standing position, set mattress to lowest position and remove bumper pads, large toys and other objects that could serve as steps for climbing out.

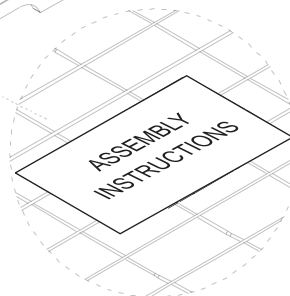

 **WARNINGS ON POUCH MUST FACE UP**

SECTION 1: CRIB ASSEMBLY

STEP 7

Parts and tools required to complete step.

Dream On Me
5 in 1 Crib

Read all instructions before assembly and use.
KEEP INSTRUCTIONS FOR FUTURE USE.
▲ **ADULT ASSEMBLY REQUIRED**
Due to the presence of small parts during assembly, keep out of reach of children until assembly is complete.



THIS PRODUCT IS NOT INTENDED FOR INSTITUTIONAL OR COMMERCIAL USE.

Consumer Care:
www.dreamonme.com
1532 S WASHINGTON AVE
PISCATAWAY TWP NJ 08854
OFFICE: 732-752-7220
CUSTOMER SERVICE: 732-366-1788

style #: _____
Date: _____

When contacting Dream On Me you will need to reference the above numbers. They can also be found on the label on the Crib End bottom rail.

To register your product for important safety alerts and updates to your product please visit www.dreamonme.com and click on Product Registration.

Assembly Instruction Booklet

Store the assembly instruction booklet in the pouch attached to the mattress support. Store all parts and tools separately, in a safe place.

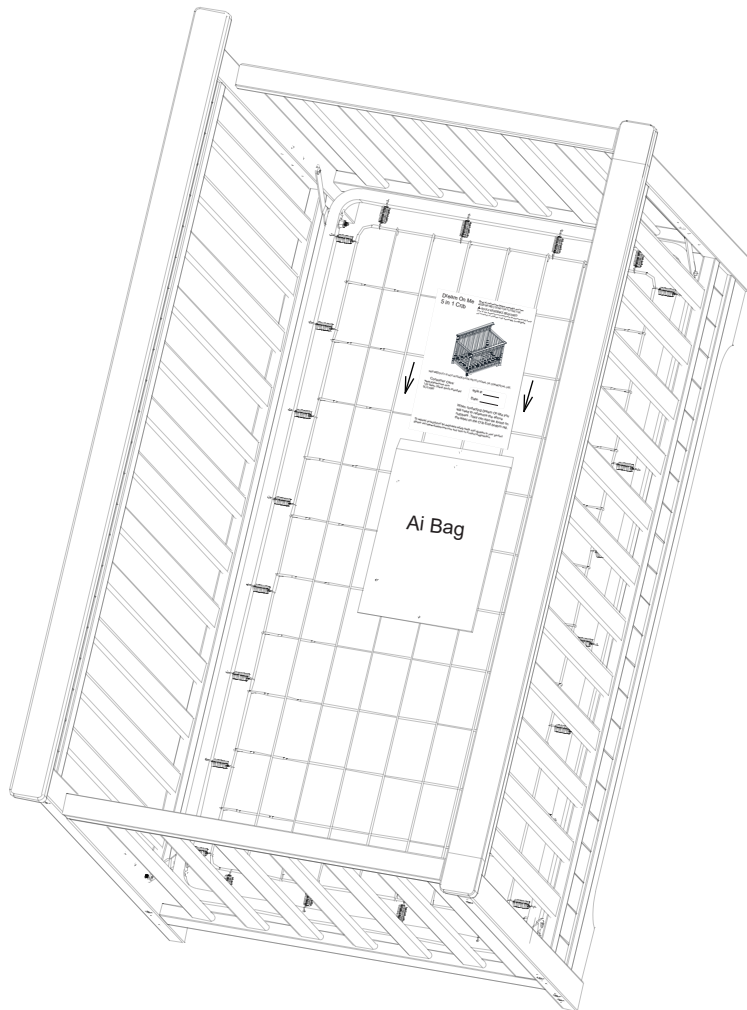

WARNING: SEE PAGE 2 FOR INFORMATION

Section 2: Toddler Bed Conversion

STEP 1

Parts and tools required to complete step.



Finished Crib



M4 ALLEN
WRENCH SUPPLIED

Remove the Front Rail installed in step 1 of section 1 Crib Assembly.

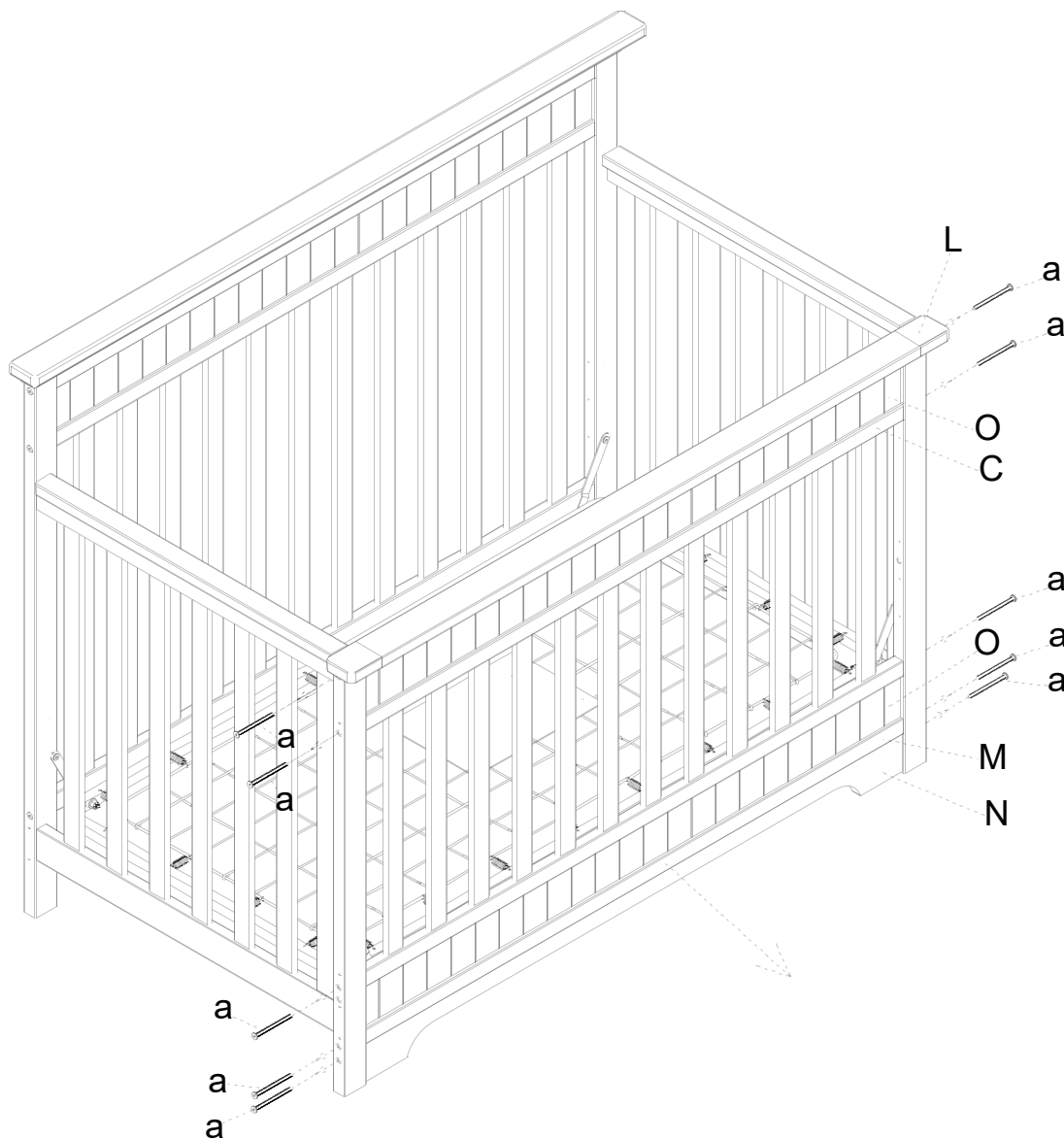

Section 2: Toddler Bed Conversion

STEP 2

Parts and tools required to complete step.

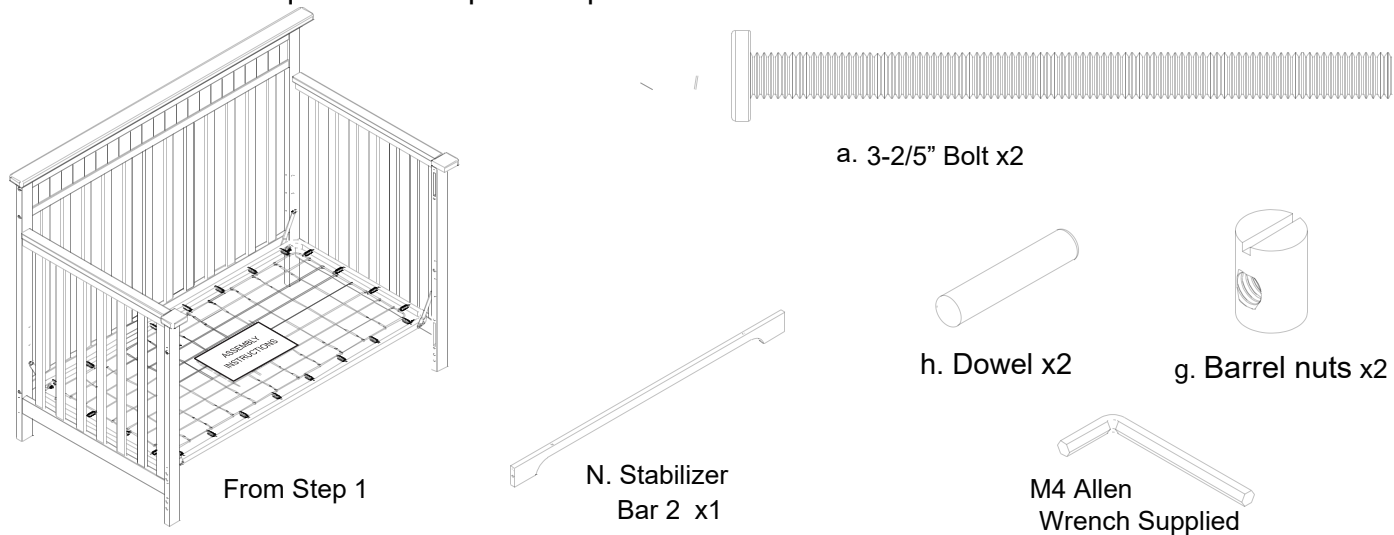

Attach (1) Stabilizer Bar (Part N) to the assembly from step 1 using (2) 3-2/5" Bolts (Part a), (2) Barrel nuts (Part g) and (2) Dowel (Part h). Tighten with the M4 Allen Wrench. Gently pull the left and right front leg apart to install the stabilizer bar - be very careful not to scratch the finish.

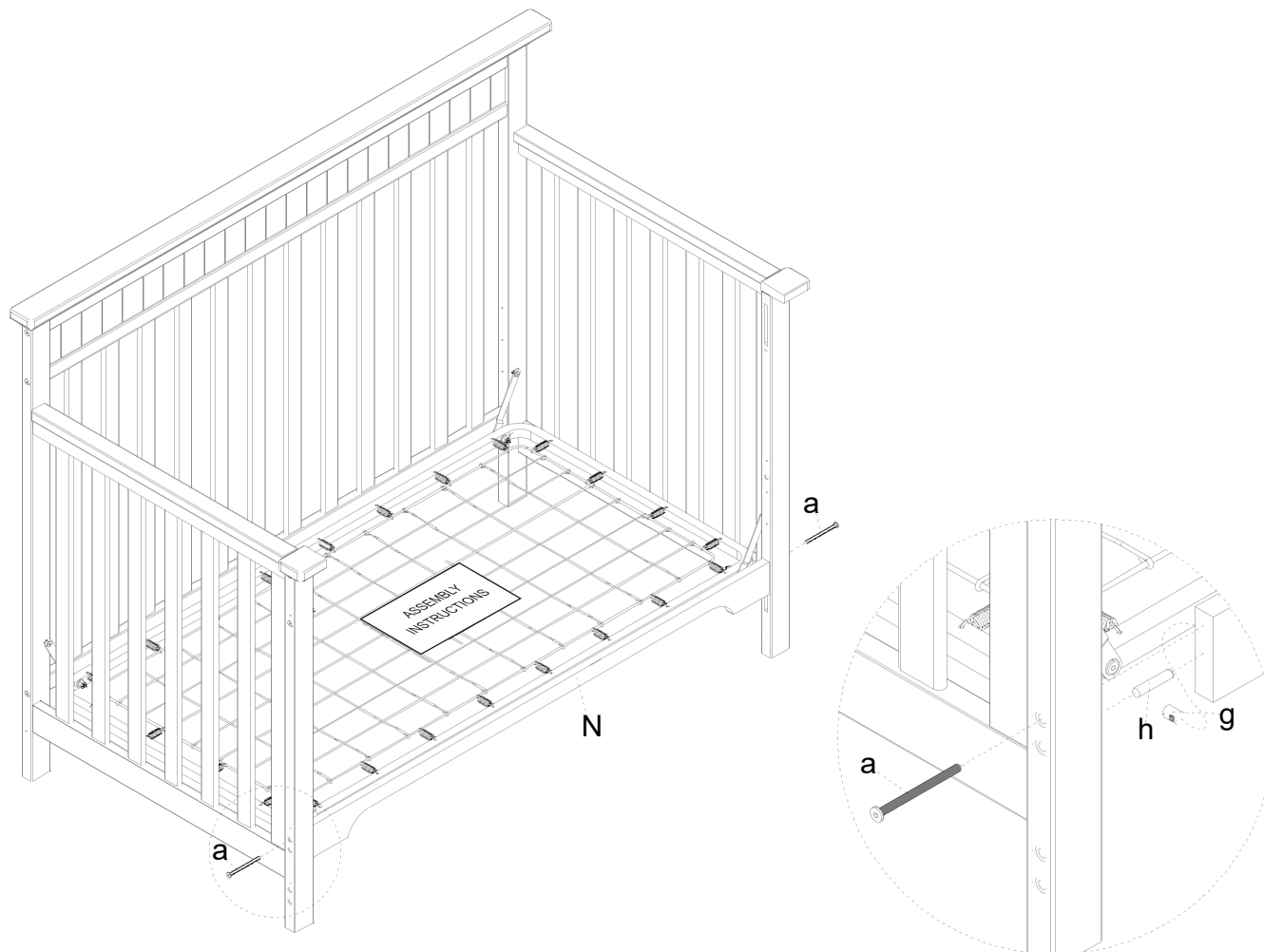

Section 2: Toddler Bed Conversion

STEP 3

⚠️ WARNING: SEE PAGE 3 FOR TODDLER BED WARNINGS

The mattress support must be in the lowest positions.

Store all hardware safely.

Read all warnings on page 3.

As shown, use as a day bed or love seat sofa.

No Not use without stabilizer bar installed.

⚠️ Stabilizer bar must be used when converted to a toddler bed.

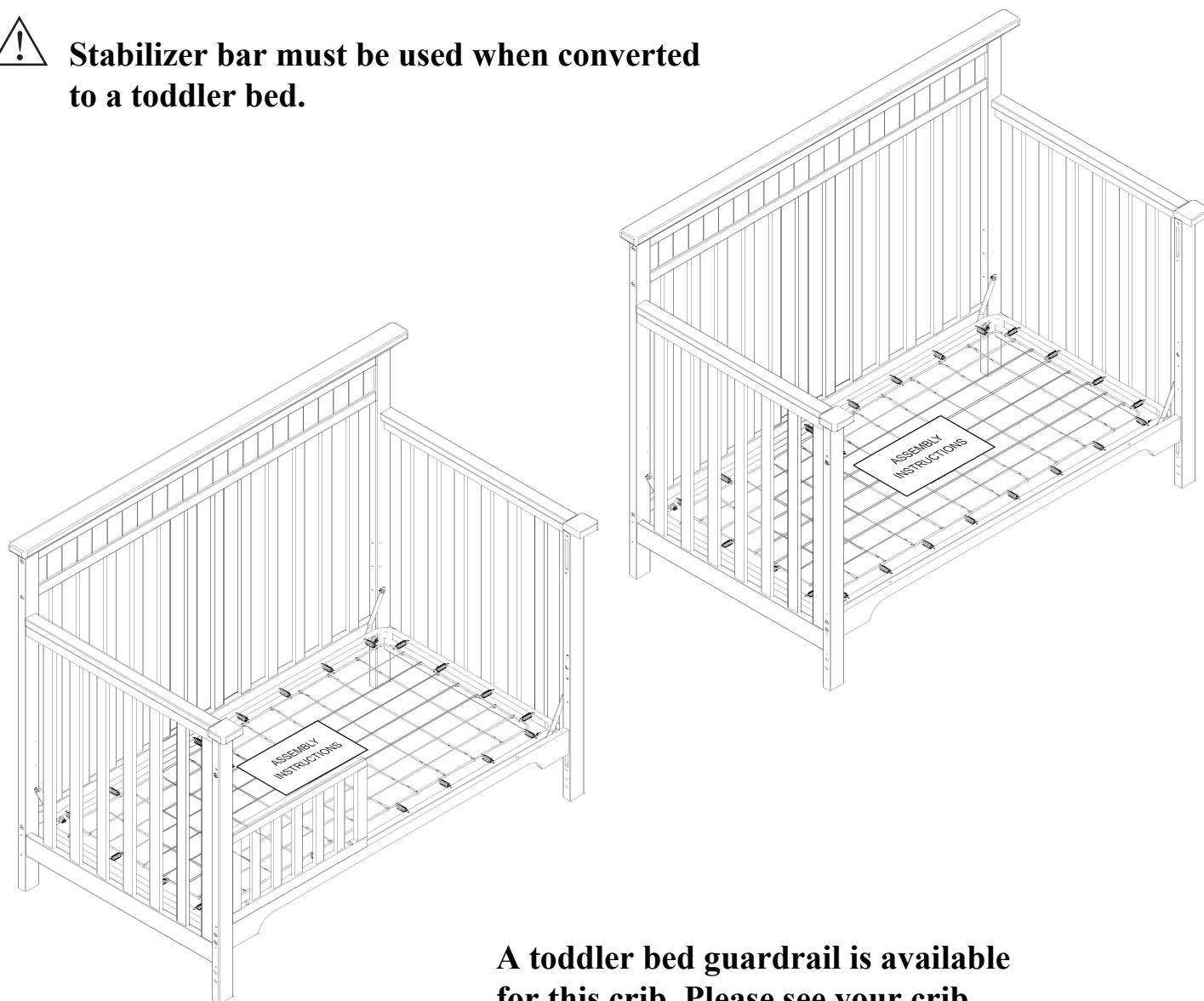

A toddler bed guardrail is available for this crib. Please see your crib retailer, visit www.dreamonme.com or contact Consumer Care for more information.

This crib uses Style #692 Guardrail.

Section 3: Full Size Bed Conversion I

STEP 1

Parts and tools required to complete step.



M4 Allen
Wrench Supplied

You have the option to convert the crib to a Full Size Bed. Simply follow steps in reverse order to disassemble the crib. Then remove the Rear Legs from the left Crib End and Right Crib END with the M4 Allen Wrench as shown.

Store all parts and hardware in a safe place..

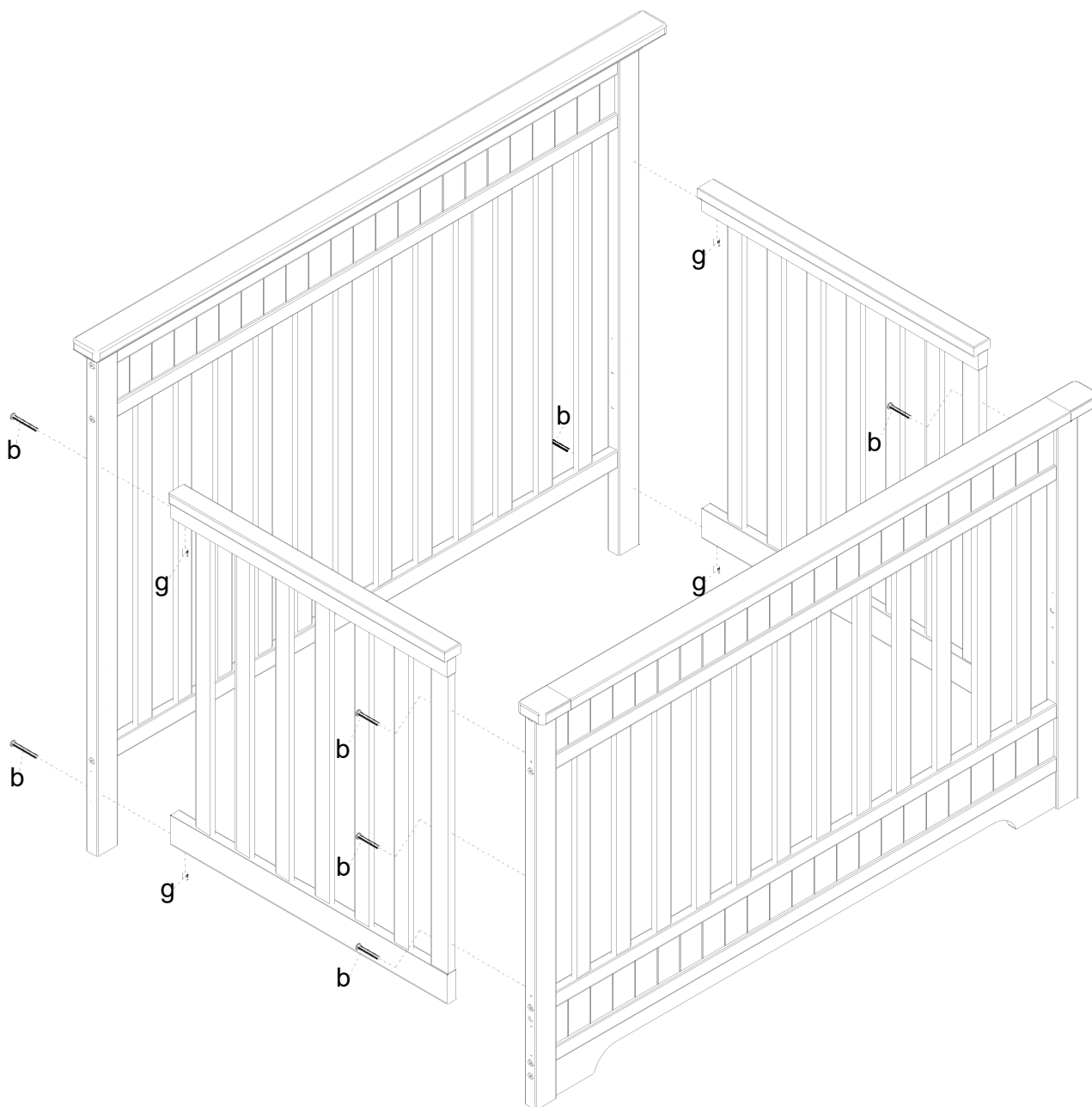

Section 3: Full Size Bed Conversion I

STEP 2 (Hollywood bed frame sold separately)

Parts and tools required to complete step.

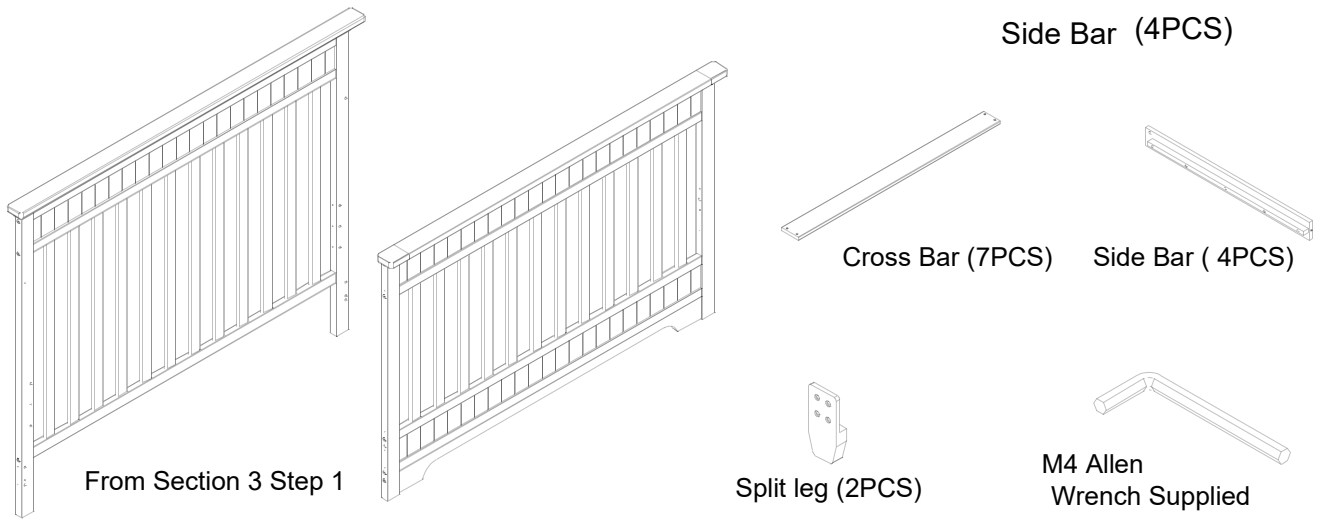

Converting kit is sold separately

You have the option to convert crib to a full size bed II

1. Insert the split leg to the left&right side bar .
2. Connect the headboard Leg to the left side bar and the right side bar.
3. Connect the footboard Leg to the left&right side bar.
4. Connect the c to the left&right side bar. cross bar to the side bar.

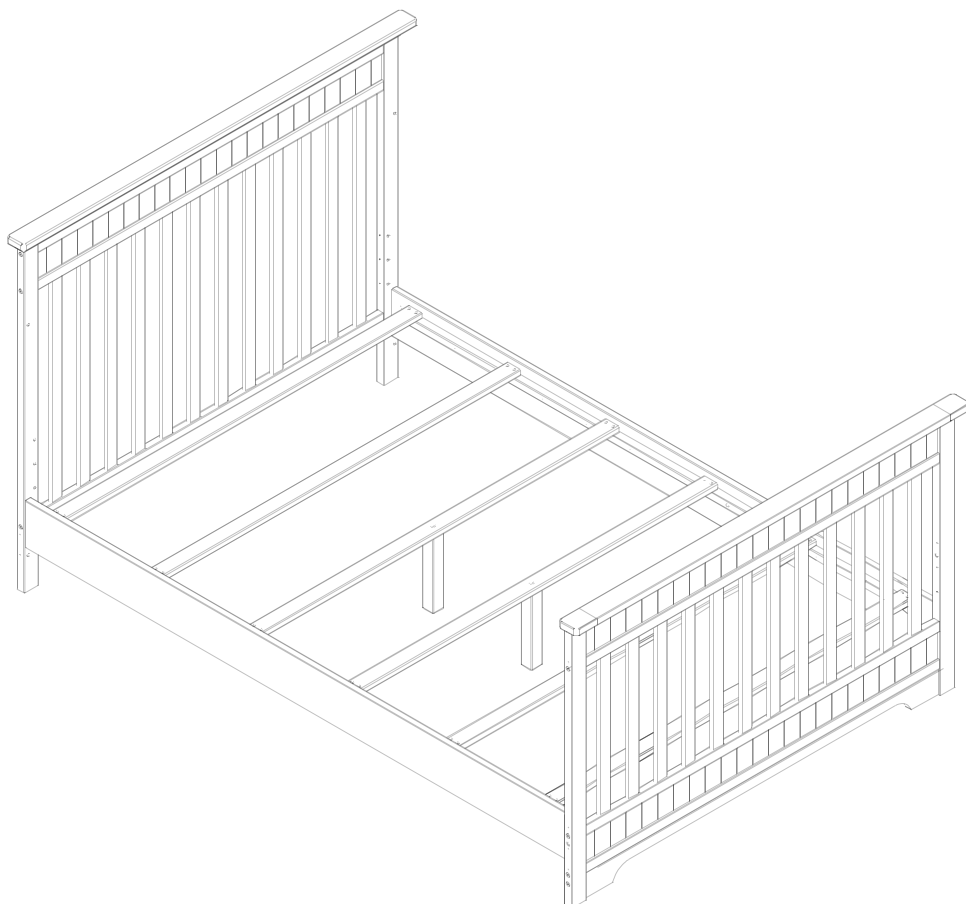

Section 3: Full Size Bed Conversion II

STEP 1 (Hollywood bed frame sold separately)

Parts and tools required to complete step.

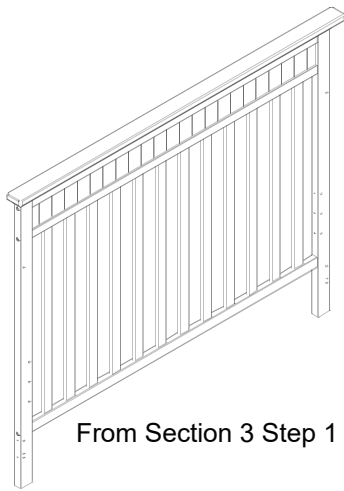

From Section 3 Step 1

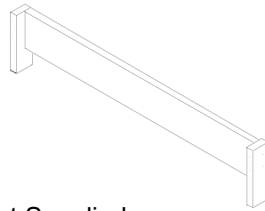

Not Supplied



Left Foot Platform Post (1pc)
Not Supplied



Right Foot Platform Post (1pc)
Not Supplied

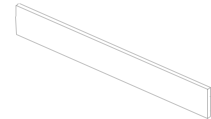

Rail Post(6pcs)
Not Supplied

Converting kit is sold separately

ou have the option to convert crib to a full size bed II

- 1:Use the back rail as the headboard of full size
- 2:Connect the left foot platform and the right foot platform to the rail which are not included and sold separately.
- 3:Connect the assembled parts and headboard o hardware) which are not included and sold sep

Le Kit de conversion est fourni séparément

Vous avez la possibilité de convertir la crèche à un lit de taille complète II

- 1.Utilisez le rail de la tête arrière du grand lit.
- 2.Connectez la plate-forme de pied gauche et la plate-forme de pied droit sur les rails qui ne sont pas inclus et vendu séparément.
- 3.Connectez les pièces assemblées et tête de lit de lit de taille pour les kits (jambes, longuesrails et le matériel) qui ne sont pas inclus et vendus séparément.

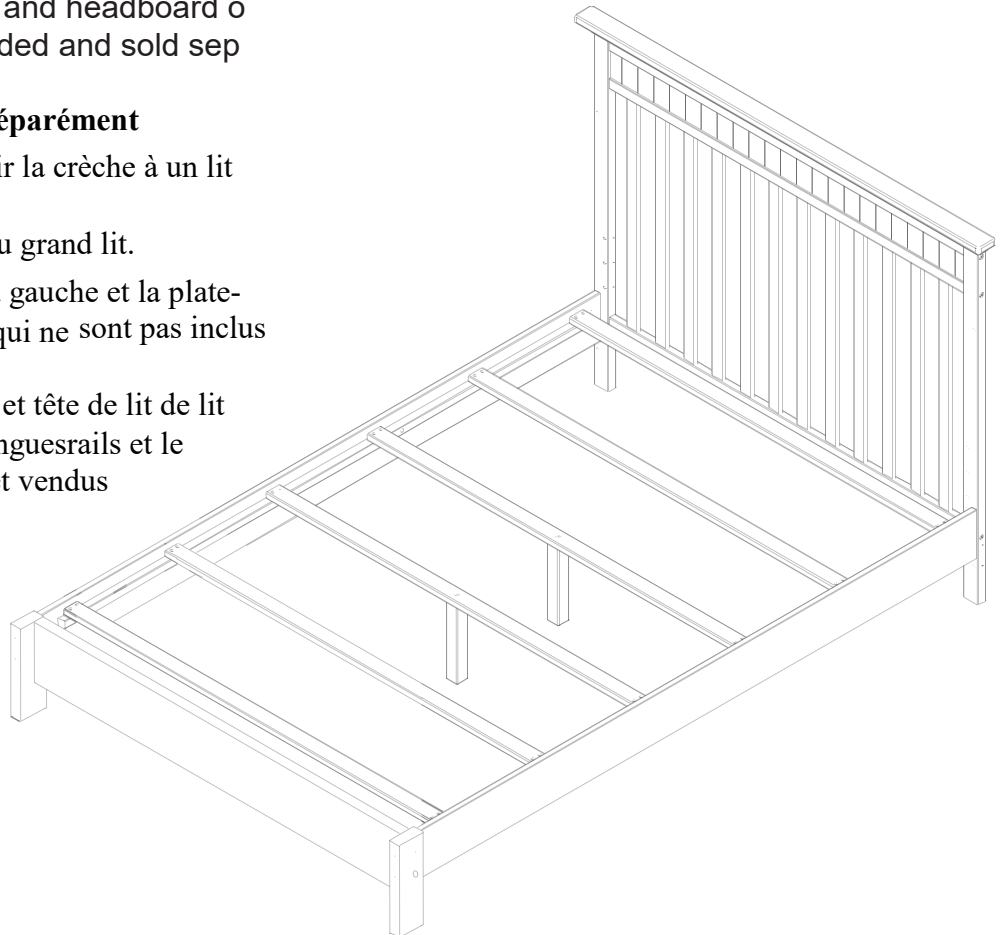

Model shown is example only.
Styles may vary .

Modèle présenté à titre indicatif.
Les styles peuvent varier.

LIMITED WARRANTY

- Dream on Me warrants its product to be free from defects in material and workmanship and agrees to remedy any such defect.
- This warranty covers 30 days from the date of original purchase.
- This warranty is valid only upon presentation of proof of purchase. This is solely limited to the repair or replacement of defective furniture components and no assembly labor is included.
- This warranty does not apply to any product which has been improperly assembled, subjected to misuse or abuse or which has been altered or repaired in any way.
- This warranty gives you specific legal rights and you may also have other rights which vary from State to State.

WARNING: Should this product become damaged, and/or components are broken or missing, DO NOT USE

To register your product for important safety alerts and updates to your product please visit www.dreamonme.com

Please do not return this item to the store before contacting us about missing parts or with any questions.

To report a problem, please log on to www.dreamonme.com and contact us by phone at 732-366-1788

In the event that you need to contact our customer service department please have the Style Number and MFG available. Use the space below to make note of those numbers. They can be found on the label on the Crib End bottom rail.

STYLE No: 761

COLOR

FTY

Lot No: _____

Pack Date: _____

Date of Purchase: _____ (you should also keep your receipt)



1532, S. Washington Avenue
Piscataway, NJ 08854
E-mail: info@dreamonme.com

www.dreamonme.com

Follow us on



[@dreamonmeinc](https://www.facebook.com/dreamonmeinc)



[@dreamonmeinc](https://www.instagram.com/dreamonmeinc)

to get your nursery featured on our social media.

Enter our monthly giveaway!

Simply scan the QRcode to register.



Chat with us!

For any questions or concerns or feedback.



DOM
FAMILY

