

ASTM EN1273 3 IN 1 BABY WALKER

INSTRUCTION MANUAL

WARNING:

PLEASE READ THESE INSTRUCTIONS CAREFULLY BEFORE USE AND RETAIN THEM IN A SAFE PLACE FOR FUTURE REFERENCE. READ ALL INSTRUCTIONS BEFORE ASSEMBLY AND USE OF THE WALKER. KEEP INSTRUCTIONS FOR FUTURE USE. THE CHILD MAY BE HURT IF YOU DO NOT FOLLOW THESE INSTRUCTIONS.

WARNING:

READ THE INSTRUCTIONS CAREFULLY BEFORE USE AND KEEP THEM FOR FUTURE REFERENCE. THE CHILD MAY GET HURT IF YOU DO NOT FOLLOW THESE INSTRUCTIONS.

NEVER LEAVE THE CHILD UNATTENDED. ALWAYS KEEP CHILD IN VIEW WHILE IN WALKER.

THE CHILD WILL BE ABLE TO REACH FURTHER AND MOVE RAPIDLY WHEN IN THE BABY WALKER.

- PREVENT ACCESS TO STAIRS, STEPS AND UNEVEN SURFACES.
- GUARD ALL FIRES, HEATING AND COOKING APPLIANCES.
- REMOVE HOT LIQUIDS, ELECTRICAL FLEXES AND OTHER POTENTIAL HAZARDS FROM REACH.
- PREVENT COLLISIONS WITH GLASS IN DOORS, WINDOWS AND FURNITURE.
- DO NOT USE THE BABY WALKER IF ANY COMPONENTS ARE BROKEN OR MISSING.
- THIS BABY WALKER SHOULD BE USED ONLY FOR SHORT PERIODS OF TIME (E.G. 20 MIN).
- THIS BABY WALKER IS INTENDED TO BE USED BY CHILDREN WHO CAN SIT UNAIDED, APPROXIMATELY FROM 6 MONTHS TO 36 MONTHS. IT IS NOT INTENDED FOR CHILDREN WEIGHING MORE THAN 26 LBS.
- DO NOT USE REPLACEMENT PARTS OTHER THAN THOSE APPROVED BY DREAM ON ME.
- USE ONLY ON FLAT SURFACES FREE OF OBJECTS THAT COULD CAUSE THE WALKER TO TIP OVER.
- DO NOT USE THE WALKER IF IT IS DAMAGED OR BROKEN.
- DO NOT USE UNTIL BABY CAN SIT UP BY ITSELF.
- CLEAN FRICTION COMPONENTS REGULARLY TO MAINTAIN STOPPING PERFORMANCE.
- TO AVOID BURNS, KEEP THE CHILD AWAY FROM HOT LIQUIDS, RANGES, RADIATORS, SPACE HEATERS, FIREPLACES, ETC.
- THE BABY WALKER IS INTENDED TO BE ASSEMBLED BY AN ADULT.

WARNING - STAIR HAZARD

AVOID SERIOUS INJURY OR DEATH - BLOCK STAIRS/STEPS SECURELY BEFORE USING WALKER EVEN WHEN USING PARKING BRAKE.

- NON-RECHARGEABLE BATTERIES ARE NOT TO BE RECHARGED.
- DIFFERENT TYPES OF BATTERIES OR NEW AND USED BATTERIES ARE NOT TO BE MIXED.
- EXHAUSTED BATTERIES ARE TO BE REMOVED FROM THE TOY.
- THE SUPPLY TERMINALS ARE NOT TO BE SHORT-CIRCUITED.
- ONLY BATTERIES OF THE SAME OR EQUIVALENT TYPE AS RECOMMENDED ARE TO BE USED.
- BATTERIES ARE TO BE INSERTED WITH THE CORRECT POLARITY.
- RECHARGEABLE BATTERIES ARE TO BE REMOVED FROM THE TOY BEFORE BEING CHARGED.
- IF USING RECHARGEABLE BATTERIES, THE BATTERIES ARE ONLY TO BE CHARGED UNDER ADULT SUPERVISION.

CARE AND MAINTENANCE

1) TO PROLONG THE LIFE OF YOUR NURSERY PRODUCT KEEP IT CLEAN AND DO NOT LEAVE IT IN THE DIRECT SUNLIGHT FOR EXTENDED PERIODS OF TIME.

2) REMOVABLE FABRIC COVERS AND PLASTIC PARTS MAY BE CLEANED USING WARM WATER WITH A HOUSEHOLD SOAP OR A MILD DETERGENT. ALLOW IT TO DRY FULLY, PREFERABLY AWAY FROM DIRECT SUNLIGHT.

3) CLEAN (FRICTION COMPONENTS) REGULARLY TO MAINTAIN STOPPING PERFORMANCE.

HELPFUL HINTS

IF THE WHEELS SQUEAK - USE A SILICON BASED SPRAY ENSURING IT PENETRATES THE WHEEL AND AXLE ASSEMBLY. DO NOT DRY CLEAN, OR USE BLEACH.

DO NOT MACHINE WASH, TUMBLE OR SPIN DRY, UNLESS THE CARE LABELLING ON THE PRODUCT PERMITS THESE METHODS. NON REMOVABLE FABRIC COVERS AND TRIMS MAY BE CLEANED USING A DAMP SPONGE WITH SOAP OR MILD DETERGENT.

ALLOW IT TO DRY COMPLETELY BEFORE FOLDING OR STORING IT AWAY.

IN SOME CLIMATES THE COVERS AND TRIMS MAY BE AFFECTED BY MOULD AND MILDEW. TO HELP PREVENT THIS OCCURRING, DO NOT FOLD OR STORE THE PRODUCT IF IT IS DAMP OR WET. ALWAYS STORE THE PRODUCT IN A WELL VENTILATED AREA.

ALWAYS CHECK PARTS REGULARLY FOR TIGHTNESS OF SCREWS, NUTS AND OTHER FASTENERS - TIGHTEN IF REQUIRED. TO MAINTAIN THE SAFETY OF YOUR NURSERY PRODUCT, SEEK PROMPT REPAIRS FOR BENT, TORN, WORN OR BROKEN PARTS.

A

Connecting the Seat and Walk-Behind Bar

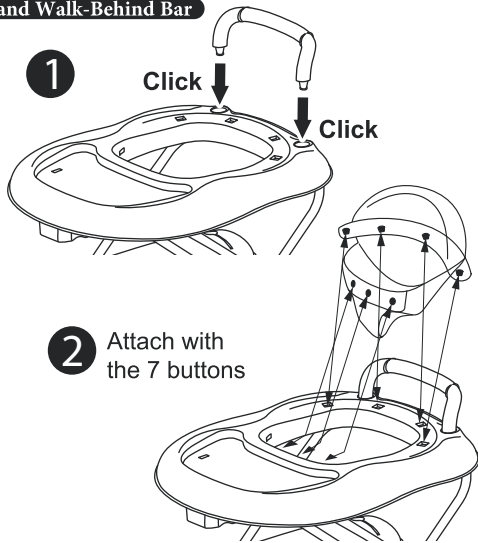

B

Attach the Wheels and Stoppers

Never use the baby-walker without the wheels.

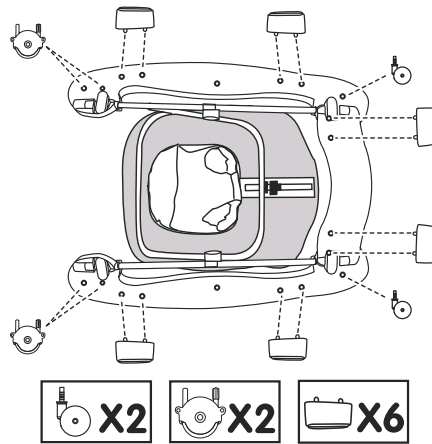

C

Assembling the Toy Tray

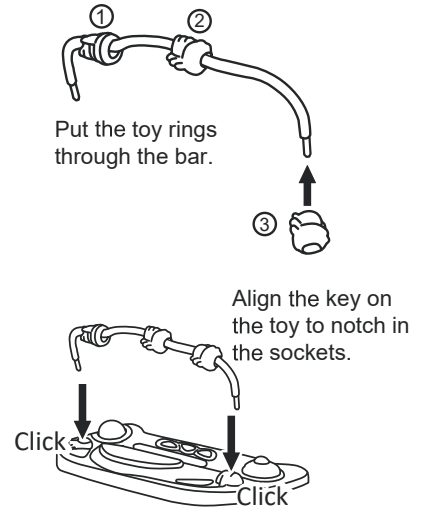

D

Folding and Unfolding the Walker

- 1 - To unfold the baby walker, remove the tray from the base.
- 2 - To adjust the height, turn the button then press it. The position locks automatically when you release the button.
- 3 - To fold the baby walker back down: turn the button, press it and lower the tray towards the base.

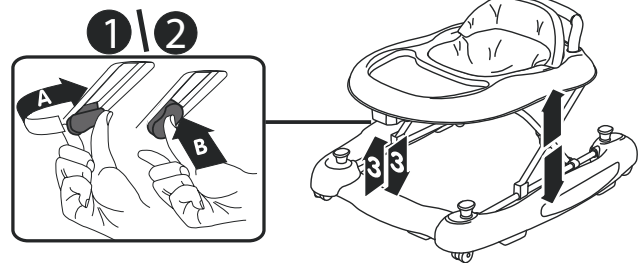

E

Using the Toy Tray

• Battery not supplied

CAUTION! Non-rechargeable batteries are not to be recharged. Rechargeable batteries are to be removed from the toy before being charged. Rechargeable batteries are only to be charged under adult supervision. Different types of batteries or new and used batteries are not to be mixed. Batteries are to be inserted with the correct polarity. Exhausted batteries are to be removed from the toy. The supply terminals are not to be short-circuited. Please follow the instructions to remove and insert the batteries.

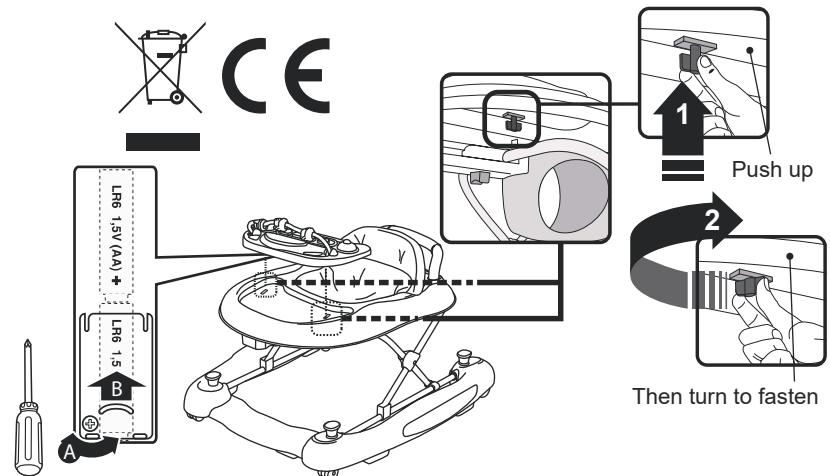

F

USE AS A ROCKER

Do not use without carpet.

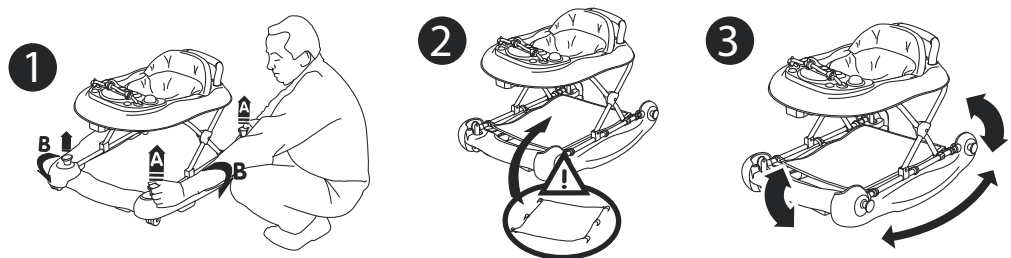

G

USE AS A BABY WALKER

Remove carpet.

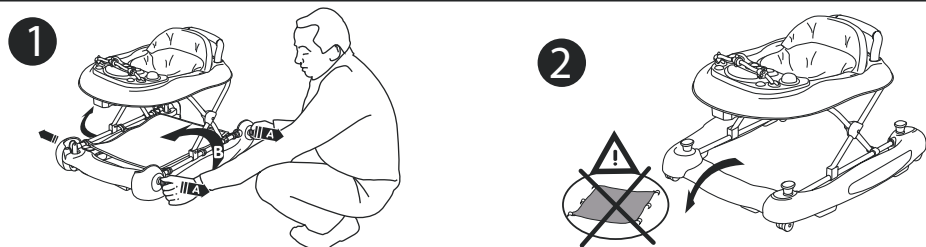

WARNING: • NEVER LEAVE THE CHILD UNATTENDED. • NOT SUITABLE FOR CHILDREN WHO ARE UNABLE TO SIT UP UNAIDED.
• NOT SUITABLE FOR CHILDREN ABLE TO WALK. • NOT APPROPRIATE FOR CHILDREN WEIGHING OVER 12 KG.

Thank you for choosing Dream On Me and congratulations on joining The DOM Family, a family that has been transforming lives for 30 years! We appreciate your feedback and wish you the very best in the coming years with your new addition. If you have any questions or concerns please don't hesitate to reach out and a trusted DOM representative will assist you. Thank you again for entrusting us to supply you with the safest, functional and affordable baby products and accessories. Feel free to follow us on Facebook and Instagram for further opportunities and offers.

Gracias por elegir Dream On Me y felicitaciones por unirse a La Familia, una familia que se ha estado expandiendo durante 30 años! Agradecemos sus comentarios y le deseamos lo mejor en los próximos años con su nueva Adición. Si tiene alguna pregunta o inquietud, no dude en comunicarse con un representante de DOM de confianza para que lo ayude. Nuevamente, gracias por confiarnos el suministro de los productos y accesorios para bebés más funcionales y económicos. Siéntase libre de seguirnos en Facebook e Instagram para más oportunidades y ofertas.



Dream On Me Inc.
1532 S Washington Ave Piscataway Twp. NJ 08854
Fax: 732-752-7221



1532, S. Washington Avenue
Piscataway, NJ 08854
E-mail: info@dreamonme.com
Customer Care: +1 (732) 366-1788

www.dreamonme.com

Follow us on

 [@dreamonmeinc](https://www.facebook.com/dreamonmeinc)  [@dreamonmeinc](https://www.instagram.com/dreamonmeinc)
to get your nursery featured on our social media.

Enter our monthly giveaway!
Simply scan the QRcode to register.

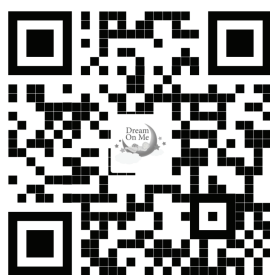

DOM
FAMILY



slumber baby

sweetpea baby

évolur
evolving with your baby